

UTILIZAR CON
MP110

EXPANSIÓN ES100

Conexión y direccionamiento
módulos serializadores UR1Z

UTILIZAR CON
MP105

UTILIZAR CON
MP108

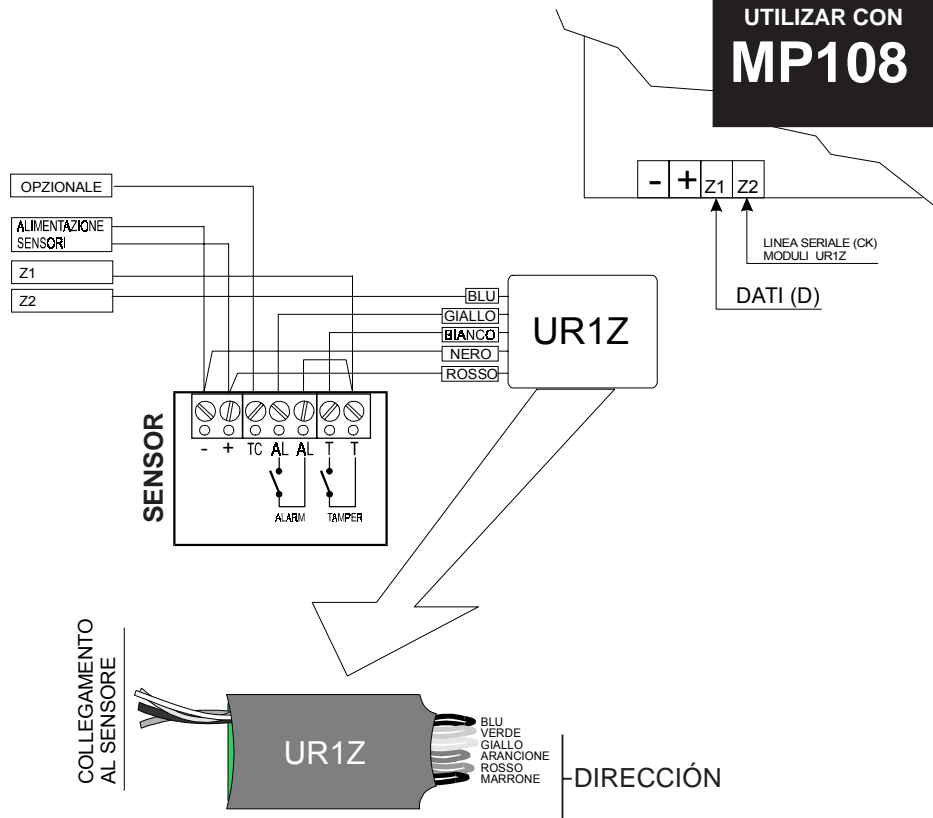

Para direccionar los sensores (máx. 8 direcciones) es suficiente cortar los puentes de colores por cable como se explica en la tabla al lado



T = cortado

DIR.	AZUL	VER	AMA	NARAN	ROJ	MARR
1						T
2					T	
3					T	T
4				T		
5				T		T
6				T	T	
7				T	T	T
8			T			

GLADIUSNET SRL
Via Dante, 37
20090 BUCCINASCO - MILANO
Tel 02 48 84 09 48 - Fax 02 36 52 86 03
C.F. e P.IVA 03423950967
www.gladiusnet.it - sales@gladiusnet.it

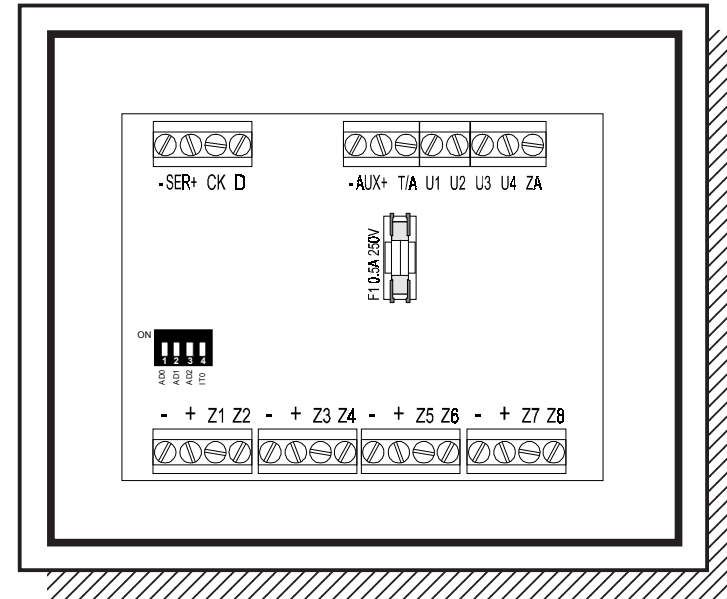

EP100



ES100

Expansione ingressi/uscite
Extension d'entrées/sorties
Inputs / outputs expansion
Expansion entradas / sortidas

pg.2
pg. 9
pg. 17
pg. 25



IS0098-AC
01.01

ELKRON

UTILIZZO CON
MP110

Descrizione della morsettiera

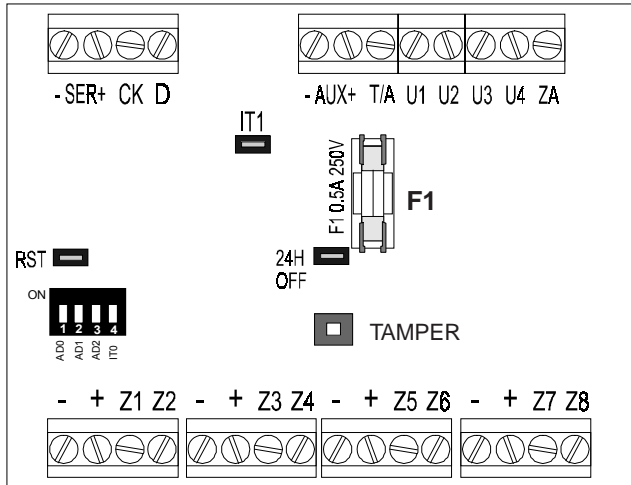

-SER Alimentazione dispositivi su linea seriale
+SER Alimentazione dispositivi su linea seriale
CK Connessione seriale (sincronismo)
D Dati

da collegare alla seriale delle tastiere e degli inseritori in centrale

-AUX Ingresso negativo di alimentaz. suppl.
+AUX Ingresso positivo di alimentaz. suppl.

utilizzare il positivo ed il negativo di centrale dedicati all'alimentazione sensori

T/A Ingresso manomissione (sempre bilanciato)
 Resistenza di bilanciamento 22 kohm

U1
U2
U3
U4

Uscite elettriche (10/20mA)

Uscite elettriche liberamente programmabili; (vedi manuale centrale)

ZA Zona ausiliaria (NC a negativo)

Per la programmazione vedi manuale centrale

- Negativo d'alimentazione
+ Positivo d'alimentazione

Zn Zona Zn
Zn Zona Zn

Disponibili per i sensori

UTILIZAR CON
MP105

Modalidades reset y cierre entradas

Reset Microprocesador - Puente RST

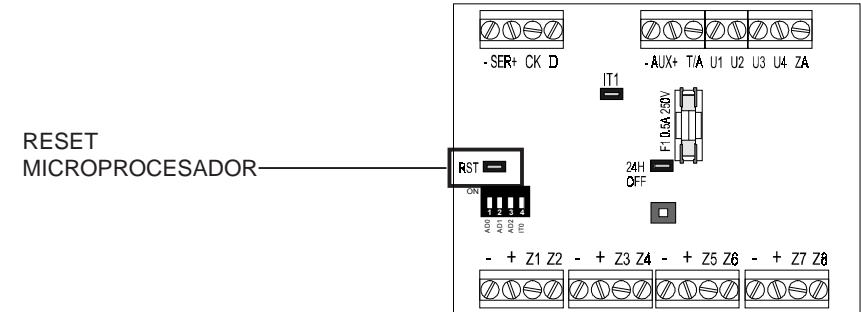

Modalidades cierre entradas

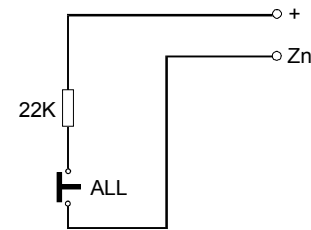

BALANCE SIMPLE



NORMALMENTE CERRADO

UTILIZAR CON
MP105 Programación

Dip 1, 2, 3 = no gestionados



Prog. Entradas - dip 4

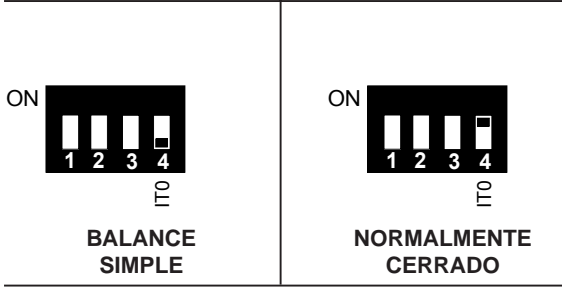

Prog. cuenta de alarmas - puente IT1

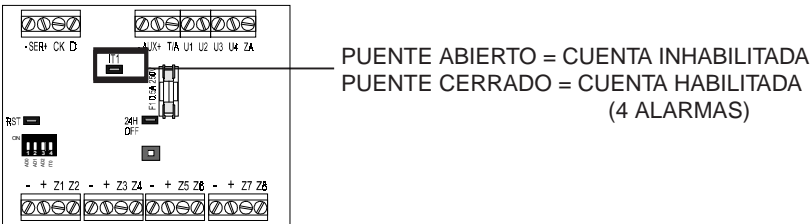

Exclusión desmontaje - Puente 24hOFF

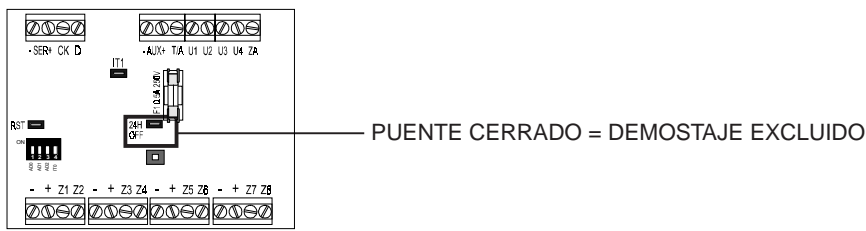

UTILIZZO CON
MP110 Programmazione

Indirizzi - dip 1, 2, 3

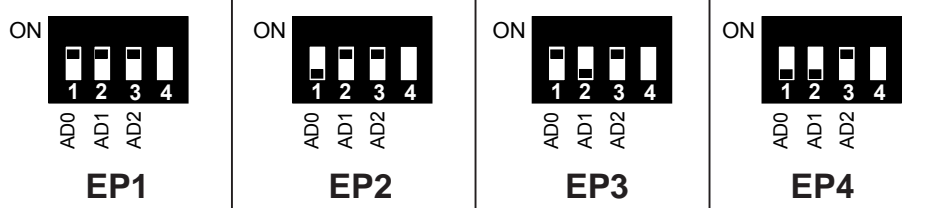

NOTA: MANTENERE IL DIP.3 (AD2) SEMPRE IN ON

Prog. Ingressi - dip 4 e ponticello IT1

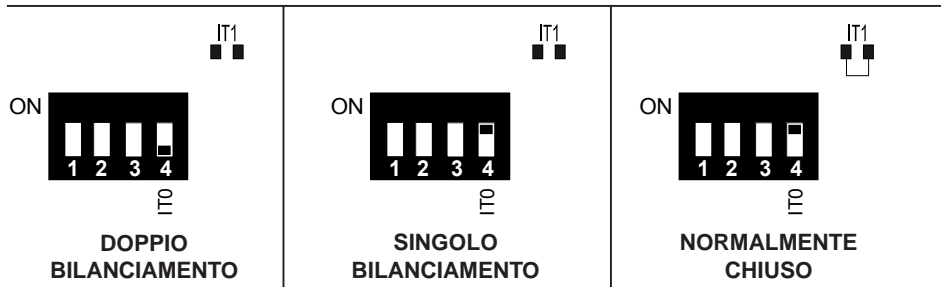

Ponticello 24hOFF = esclusione tamper

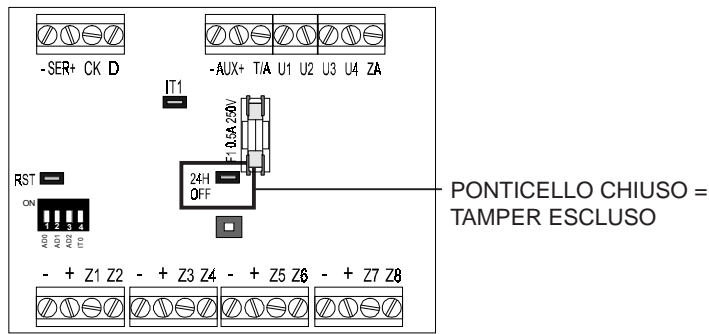

UTILIZZO CON
MP110

Modalità reset e chiusura ingressi

Reset Microprocessore - ponticello RST

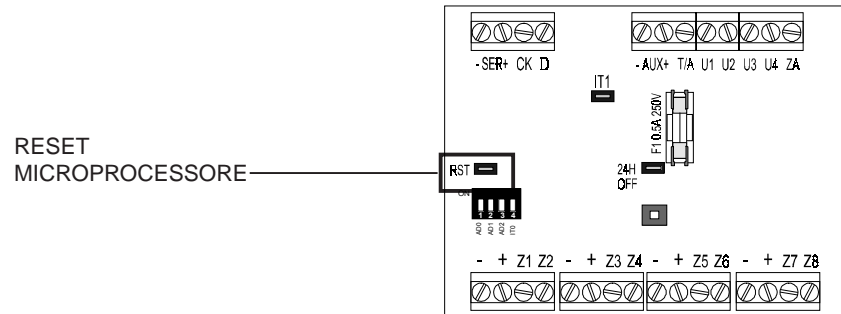

Modalità chiusura ingressi

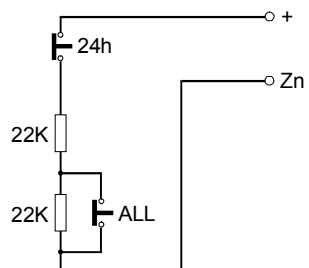

DOPPIO BILANCIAMENTO

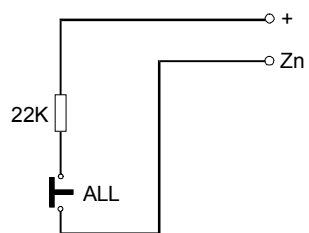

SINGOLO BILANCIAMENTO

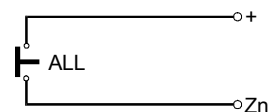

NORMALMENTE CHIUSO

UTILIZAR CON
MP105

Descripción de la bornera

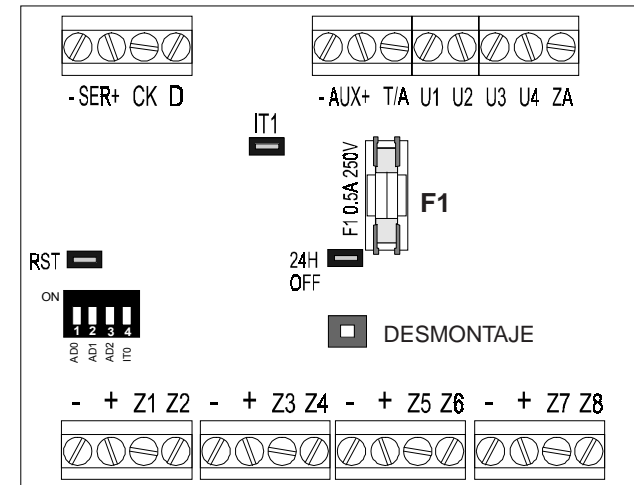

ATENCIÓN
Las zonas de la expansión indicadas como Z1, Z2, Z3, Z4, Z5, Z6, Z7, Z8 corresponden respectivamente a las zonas de la MP105: Z6, Z7, Z8, Z9, Za, Zb, Zc y Zd

- SER Alimentación dispositivos por línea serial
- +SER Alimentación dispositivos por línea serial
- CK Conexión serial (sincronismo)
- D Datos

conectar a la serial de los teclados y de los conectores en la central

- AUX Entrada negativa de alimentac. suplem.
- +AUX Entrada positiva de alimentac. suplem.

utilizar el positivo y el negativo de la central específicos para alimentación sensores

- T/A Entrada manipulación (siempre equilibrada)
Resistencia de balance 22 kohm

- U1 Salida TC1
- U2 Salida TC2
- U3 No utilizado
- U4 No utilizado

- ZA No utilizado

- Negativo de alimentación
- + Positivo de alimentación
- Zn Zona Zn
- Zn Zona Zn

Disponibles para los sensores

UTILIZAR CON
MP110

Modalidades reset y cierre entradas

UTILIZAR CON
MP108

Reset Microprocesador - Puente RST

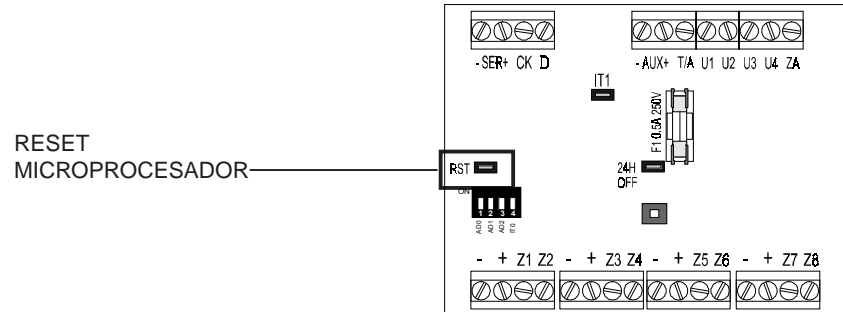

Modalidades cierre entradas

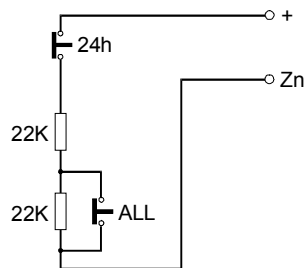

BALANCE DOBLE

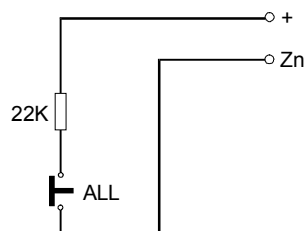

BALANCE SIMPLE

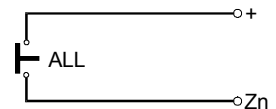

NORMALMENTE CERRADO

UTILIZZO CON
MP105

Descrizione della morsettiera

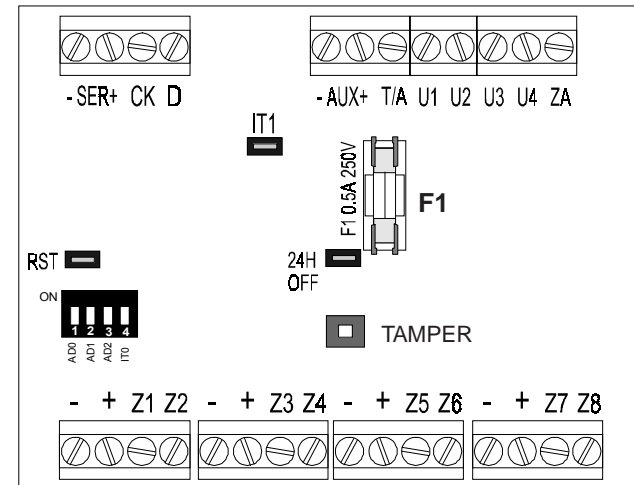

ATTENZIONE

Le zone dell'espansione indicate come Z1, Z2, Z3, Z4, Z5, Z6, Z7, Z8 corrispondono rispettivamente alle zone della MP105: Z6, Z7, Z8, Z9, Za, Zb, Zc e Zd

-SER Alimentazione dispositivi su linea seriale
+SER Alimentazione dispositivi su linea seriale
CK Connessione seriale (sincronismo)
D Dati

da collegare alla seriale delle tastiere e degli inseritori in centrale

-AUX Ingresso negativo di alimentaz. supplm.
+AUX Ingresso positivo di alimentaz. supplm.

utilizzare il positivo ed il negativo di centrale dedicati all'alimentazione sensori

T/A Ingresso manomissione (sempre bilanciato)
Resistenza di bilanciamento 22 kohm

U1 Uscita TC1
U2 Uscita TC2
U3 Non utilizzato
U4 Non utilizzato

ZA Non utilizzato

- Negativo d'alimentazione
+ Positivo d'alimentazione
Zn Zona Zn
Zn Zona Zn

Disponibili per i sensori

UTILIZZO CON
MP105 Programmazione

Dip 1, 2, 3 = non gestiti

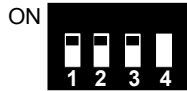

Prog. Ingressi - dip 4



Prog. conteggio allarmi - ponticello IT1

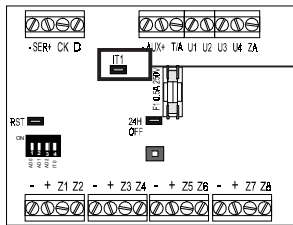

PONTICELLO APERTO = CONTEGGIO DISABILITATO
PONTICELLO CHIUSO = CONTEGGIO ABILITATO
(4 ALLARMI)

Esclusione tamper - Ponticello 24hOFF

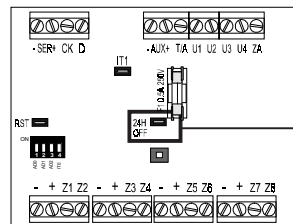

PONTICELLO CHIUSO = TAMPER ESCLUSO

UTILIZAR CON
MP108 Programación

Direcciones - dip 1, 2, 3

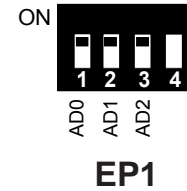

Prog. Entradas - dip 4 y Puente IT1

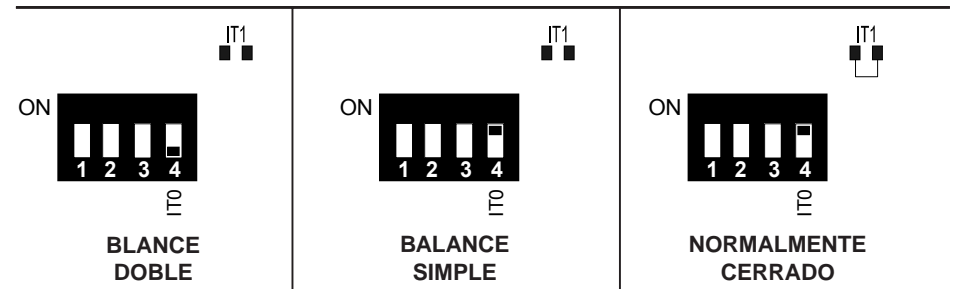

Puente 24hOFF = exclusión desmontaje

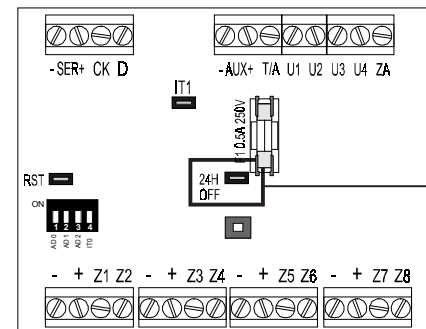

PUENTE CERRADO =
DESMONTAJE
EXCLUIDO

UTILIZAR CON
MP110

Programación

Direcciones - dip 1, 2, 3

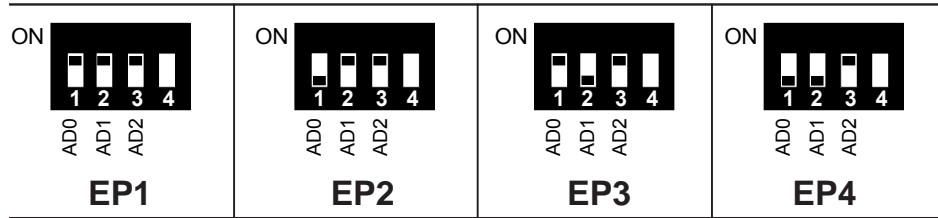

NOTA: MANTENER SIEMPRE EN ON EL DIP.3 (AD2)

Prog. Entradas - dip 4 y Puente IT1

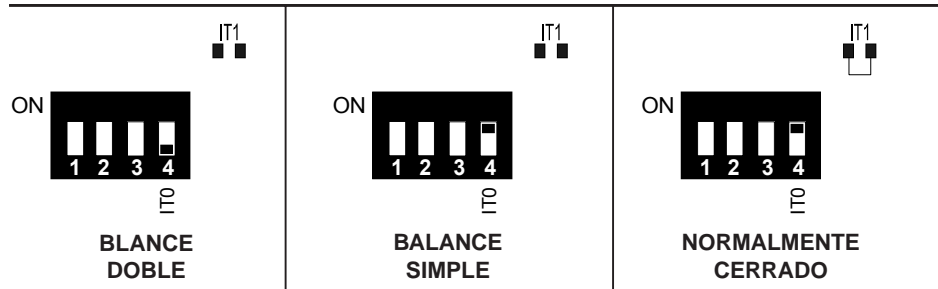

Puente 24hOFF = exclusión desmontaje

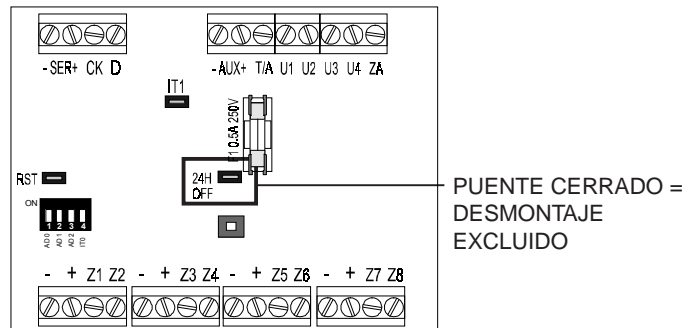

UTILIZZO CON
MP105

Modalità reset e chiusura ingressi

Reset Microprocessore - ponticello RST

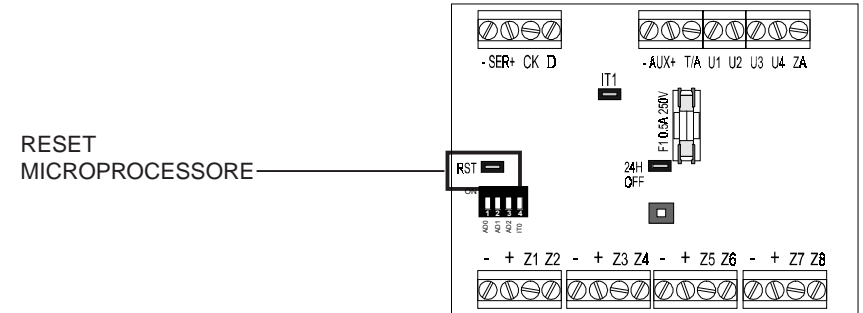

Modalità chiusura ingressi

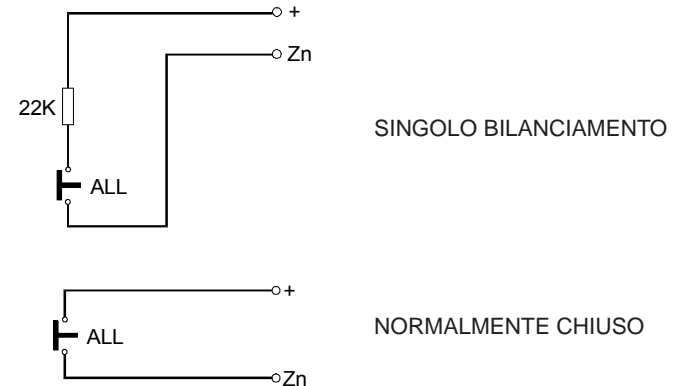

UTILIZZO CON
MP110

ESPANSIONE ES100

Collegamento e indirizzamento
moduli serializzatori UR1Z

UTILIZZO CON
MP105

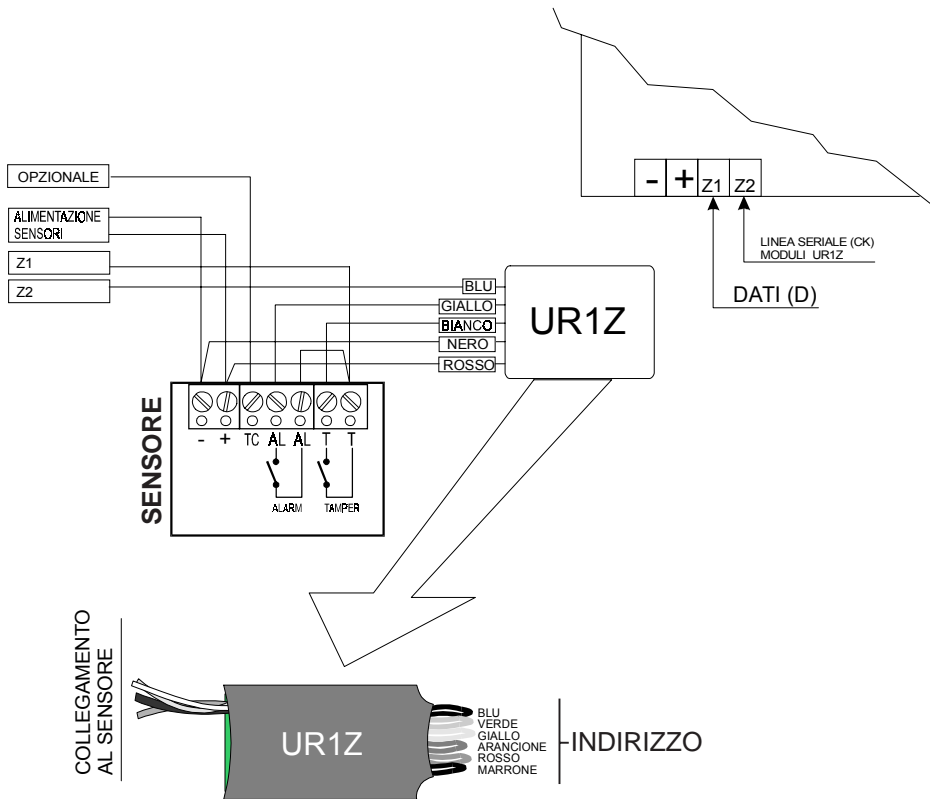

COLLEGAMENTO
AL SENSORE

INDIRIZZO

Per indirizzare i sensori (max 8 indirizzi) è sufficiente tagliare i ponticelli a filo colorati come da tabella a lato



T = tagliato

IND.	BLU	VER	GIA	ARAN	ROS	MAR
1						T
2					T	
3					T	T
4				T		
5				T		T
6				T	T	
7				T	T	T
8			T			

UTILIZAR CON
MP110

Descripción de la bornera

UTILIZAR CON
MP108

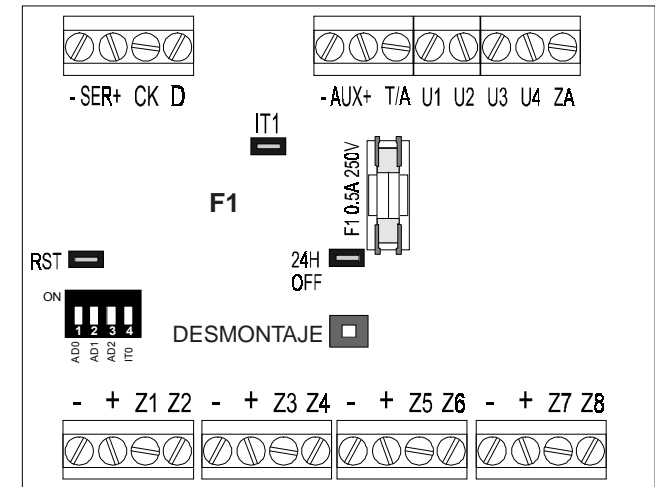

-SER
+SER
CK
D

Alimentación dispositivos por línea serial
Alimentación dispositivos por línea serial
Conexión serial (sincronismo)
Datos

*conectar a la serial de los
teclados y de los
conectores en la central*

-AUX
+AUX

Entrada negativa de alimentac. suplem.
Entrada positiva de alimentac. suplem.

*utilizar el positivo y el negativo de la
central específicos para alimentación
sensores*

T/A

Entrada manipulación (siempre equilibrada)
Resistencia de balance 22 kohm

U1
U2
U3
U4

Salidas eléctricas (10/20mA)

*Salidas eléctricas programables libre-
mente; (ver manual de la central)*

ZA

Zona auxiliar (NC con negativo)

*Para la programación ver manual de la
central*

-
+
Zn
Zn

Negativo de alimentación
Positivo de alimentación
Zona Zn
Zona Zn

Disponibles para los sensores

USED WITH
MP110

ES100 EXPANSION UR1Z Serializer Modules Connection and Addressing

USED WITH
MP105

USED WITH
MP108

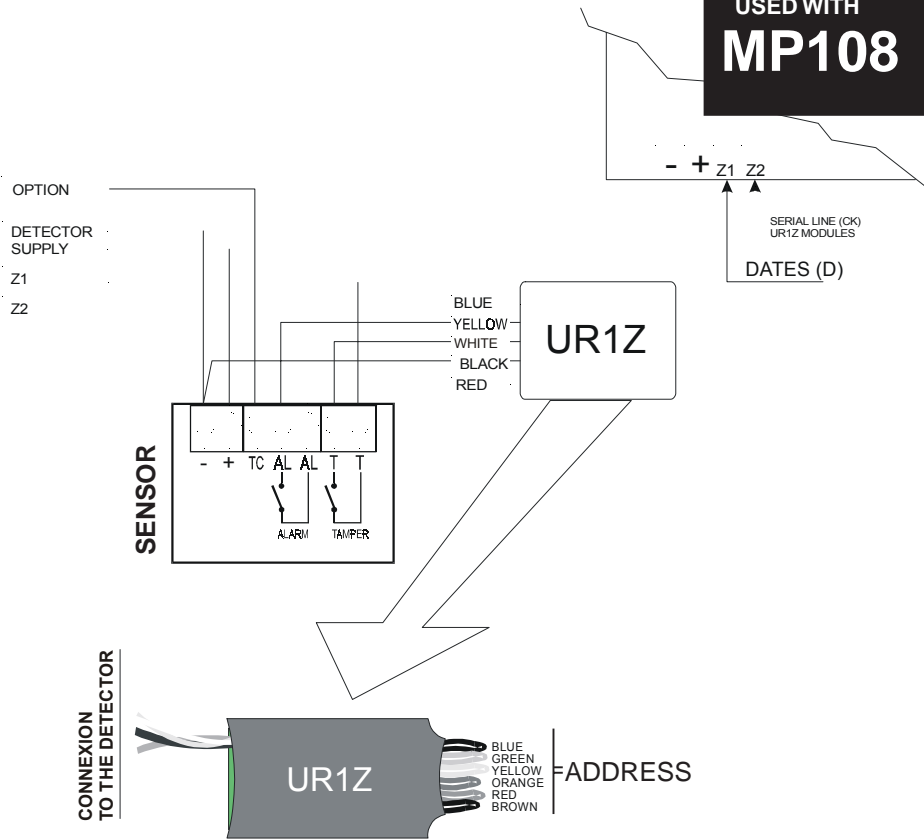

To address sensors (max of 8 addresses), simply cut the jumpers with colored wire, as indicated in the table at side

T = cut

ADD.	BLUE	GREE	YEL	ORAN	RED	BROW
1						T
2					T	
3					T	T
4				T		
5				T		T
6				T	T	
7				T	T	T
8			T			

UTILISATION AVEC
MP110

Description des borniers

UTILISATION AVEC
MP108

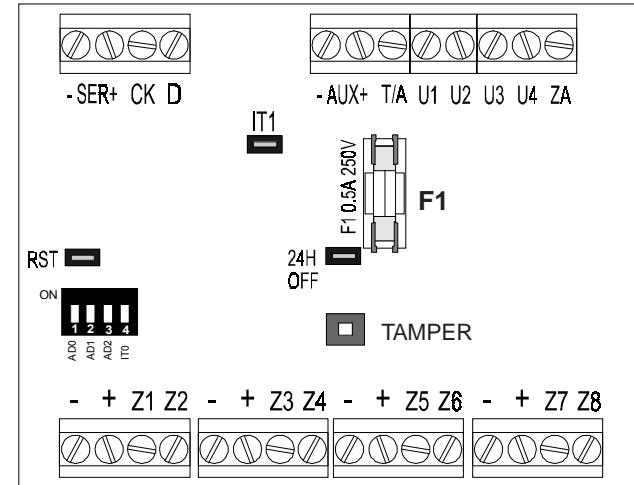

-SER Alimentation dispositifs sur liaison série
SER+ Alimentation dispositifs sur liaison série
CK Liaison série (synchronisation)
D Données

à connecter à la liaison série des claviers et des lecteurs dans la centrale

-AUX Négatif d'alimentation auxiliaire
+AUX Positif d'alimentation auxiliaire

Entrées pas l'alimentation supplémentaire indispensable quand sur les zones Z1, Z2...Z8 sont reliés des détecteurs IRP, HYPER, etc. (il va fournir l'alimentation sur toutes - et + des borniers)

T/A Entrée sabotage (rapporté au positif)
Seulement NF et toujours équilibré (22 kohm)

U1
U2 Sorties electriques faible courant (10/20mA)
U3
U4

Sorties electriques faible courant programmables vol, sabotage, panique, incendie, technique, panique silencieuse, carillon, LPA, TC1, TC2, TC3 OR-TC

ZA Zone anomalie (seulement NF au negatif)

- Négatif d'alimentation
+ Positif d'alimentation
Zn Entrée Zn
Zn Entrée Zn

Adresses - dip 1, 2, 3

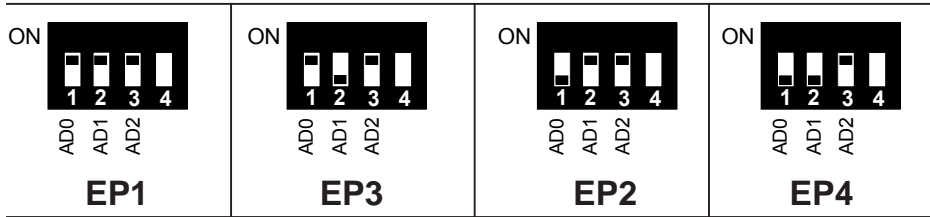

NE PAS TOUCHER LE DIP N.3 (DOIT ETRE TOUJOURS EN ON)

Fermeture entrée - dip 4 et cavalier IT1

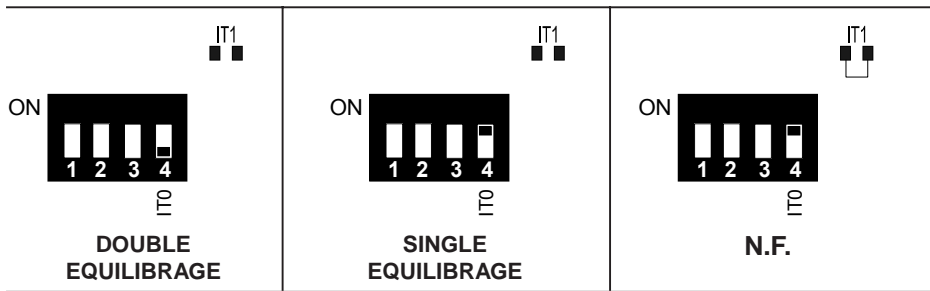

VALEUR DE LA RESISTANCE = 22 Kohm

Exclusion tamper - cavalier 24hOFF

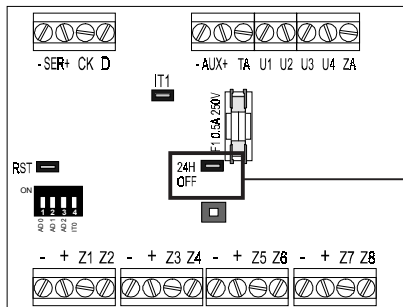

CAVALIER FERME =
TAMPER EXCLU

Microprocessor reset - RST jumper

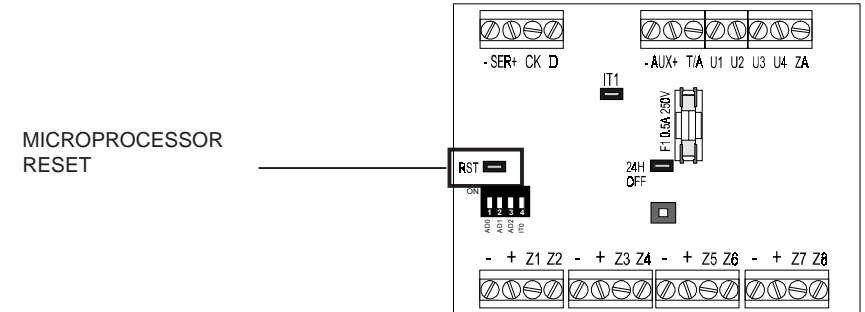

Input closing procedure

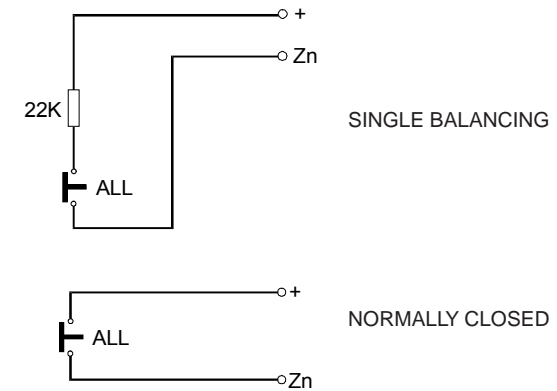

USED WITH
MP105 Programming

Dip switches 1, 2, 3 = not managed

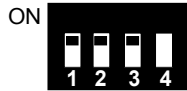

Input Program. - dip 4

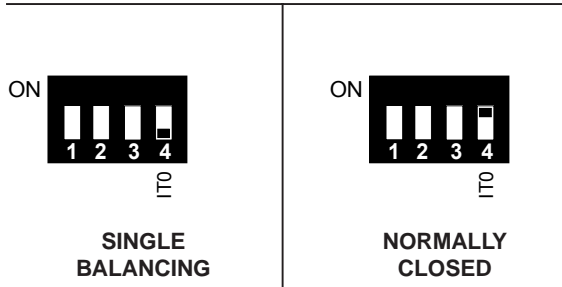

Program.of alarms count - IT1 jumper

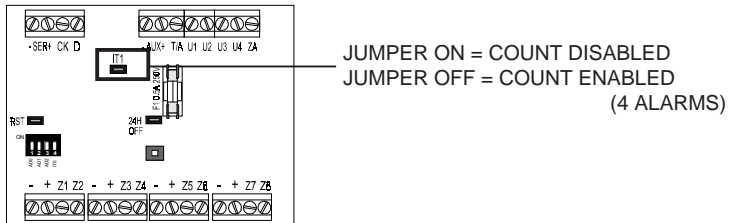

Tamper bypassed - Jumper 24hOFF

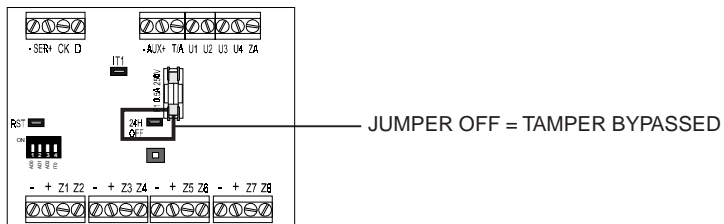

UTILISATION AVEC
MP108 Programmation

Adresses - dip 1, 2, 3

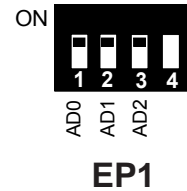

Fermeture entrée - dip 4 et cavalier IT1

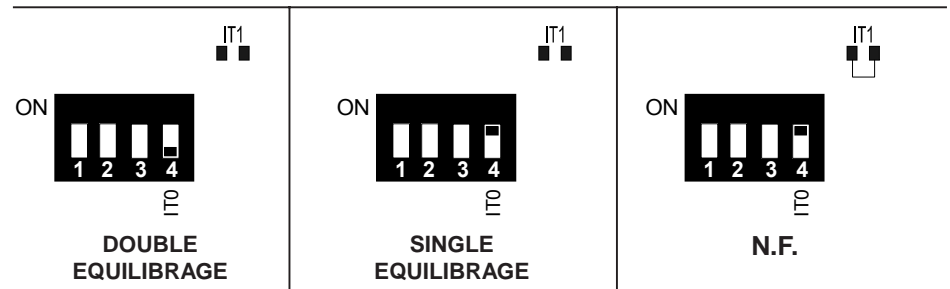

VALEUR DE LA RESISTANCE = 22 Kohm

Exclusion tamper - cavalier 24hOFF

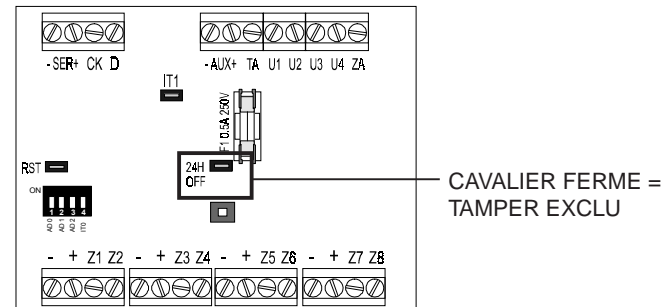

UTILISATION AVEC
MP110

Modalité fermeture adresses et RAZ

UTILISATION AVEC
MP108

RAZ du microprocesseur - cavalier RST

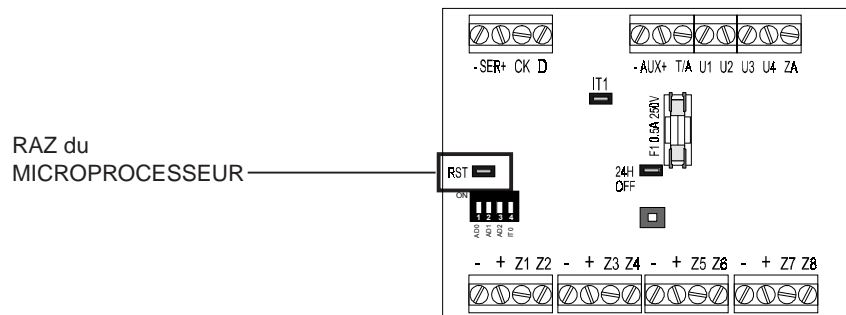

Modalité fermeture adresses

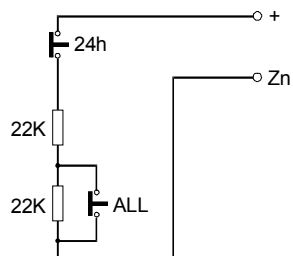

résistance double connectées

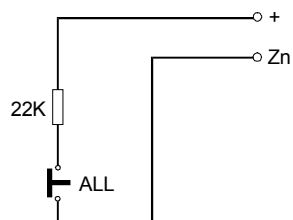

résistance simple connectées

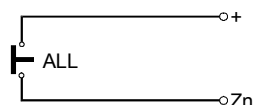

Zones programmées non équilibrées

USED WITH
MP105

Terminal Board Description

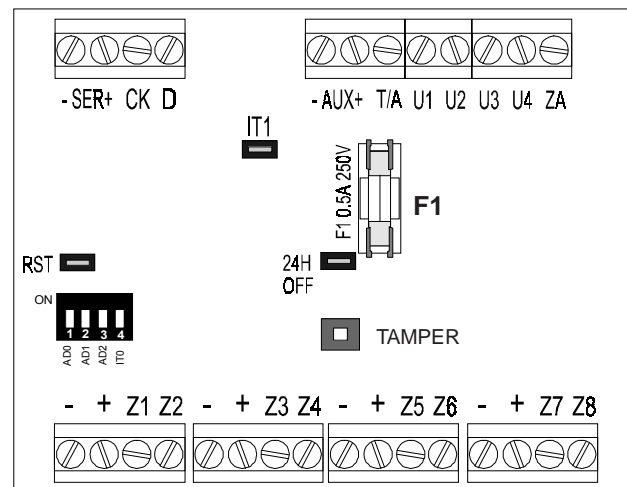

ATTENTION
The expansion zones indicated as Z1, Z2, Z3, Z4, Z5, Z6, Z7, and Z8 correspond to the following MP 105 zones, respectively: Z6, Z7, Z8, Z9, Za, Zb, Zc and Zd

-SER Serial line power supply to devices
+SER Serial line power supply to devices
CK Serial connection synchronism)
D Data

to be connected to the keypad and commutator serial line inside the unit

-AUX Negative auxiliary power supply input
+AUX Positive auxiliary power supply input

use the positive and negative unit inputs used to supply sensors

T/A Tamper input (always balanced)
22 kohm balancing resistance

U1 TC1 Output
U2 TC2 Output
U3 Not utilized
U4 Not utilized

ZA Not utilized

- Power supply negative
+ Power supply positive
Zn Zn Zone
Zn Zn Zone

Available for sensors

USED WITH
MP110

Input reset and closing procedure

USED WITH
MP108

Microprocessor reset - RST jumper

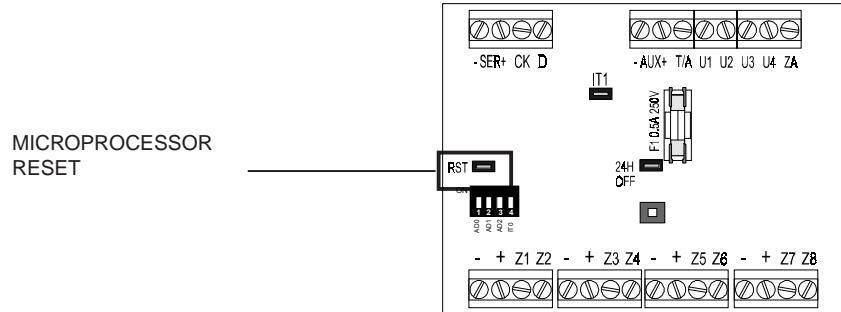

Input closing procedure

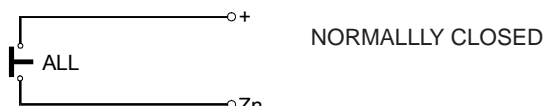
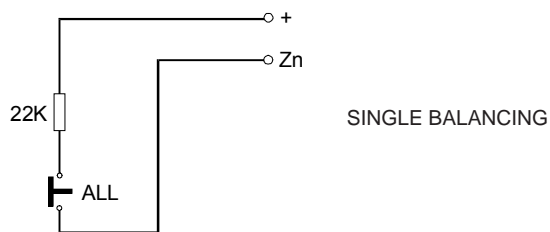
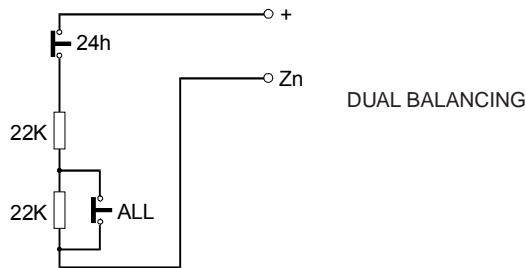

UTILISATION AVEC
MP105

Description des borniers

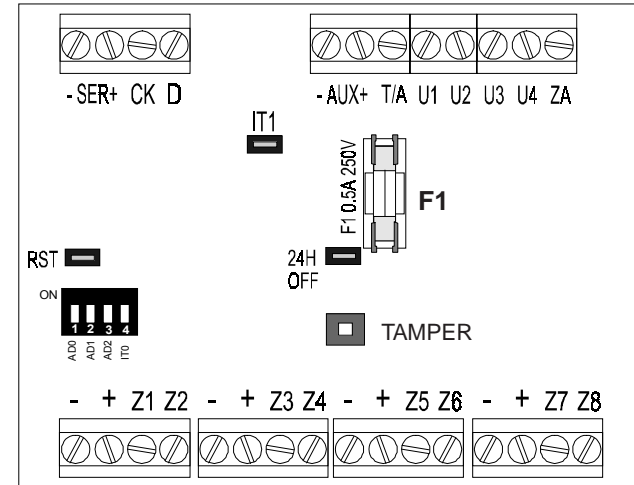

ATTENTION
Les zones de l'expansion indiquées avec Z1, Z2, Z3, Z5, Z6, Z7 et Z8 correspondent respectivement aux zones de la MP105: Z6, Z7, Z8, Z9, Za, Zb, Zc et Zd

- SER Alimentation dispositifs sur liaison série
- SER+ Alimentation dispositifs sur liaison série
- CK Liaison série (synchronisation)
- D Données

à connecter à la liaison série des claviers et des lecteurs dans la centrale

- AUX Négatif d'alimentation auxiliaire
- +AUX Positif d'alimentation auxiliaire

Entrées pas l'alimentation supplémentaire indispensable quand sur les zones Z1, Z2...Z8 sont reliés des détecteurs IRP, HYPER, etc. (il va fournir l'alimentation sur toutes - et + des borniers)

- T/A Entrée sabotage (rapporté au positif)
Seulement NF et toujours équilibré (22 kohm)

- U1 Sortie TC1
- U2 Sortie TC2
- U3 Pas utilisée
- U4 Pas utilisée

- ZA Zone anomalie (seulement NF au négatif)

- Négatif d'alimentation
- + Positif d'alimentation
- Zn Entrée Zn
- Zn Entrée Zn

Dip 1, 2, 3 = pas gérés



Prog. entrées - dip 4



Prog. comptage des alarmes - Cavaliers IT1

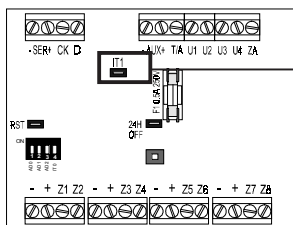

CAVALIER OUVERT = COMPTAGE DESHABILITE
CAVALIER FERME = COMPTAGE HABILITE
(4 ALARMES)

Exclusion tamper - Cavalier 24hOFF

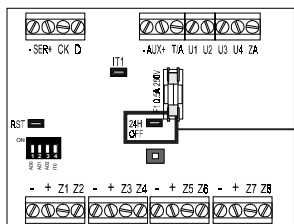

CAVALIER FERME = TAMPER DESHABILITE

Addresses - dip switches 1, 2, 3



Inputs Program. - dip 4 and IT1 jumper

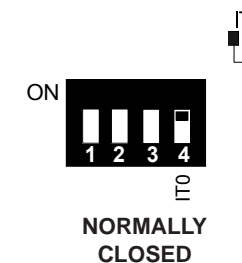
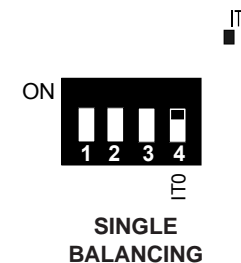
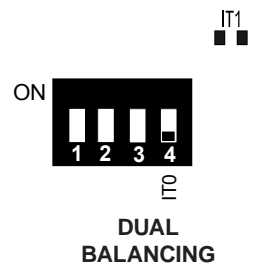

Jumper 24hOFF = tamper bypassed

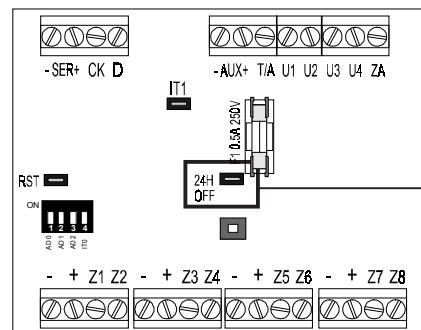

JUMPER OFF =
BYPASSED TAMPER

USED WITH
MP110

Programming

Addresses - dip switches 1, 2, 3

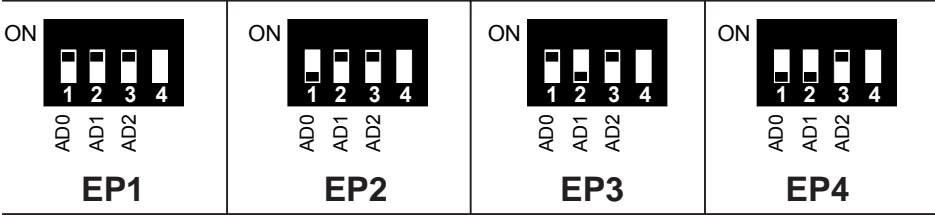

NOTE: ALWAYS KEEP DIP 3 (AD2) SET TO ON

Inputs Program. - dip 4 and IT1 jumper

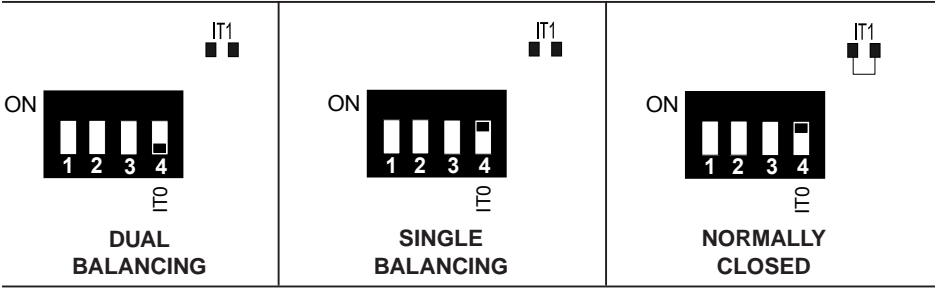

Jumper 24hOFF = tamper bypassed

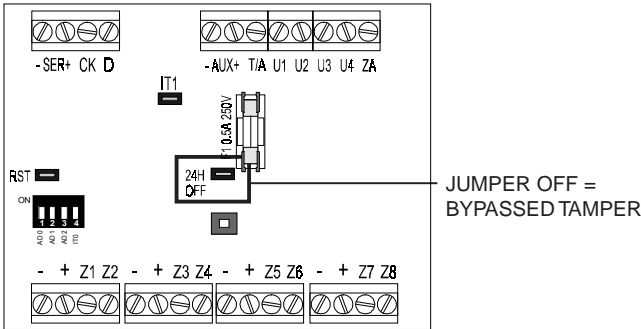

UTILISATION AVEC
MP105

Modalité fermeture adresses et RAZ

RAZ du microprocesseur - cavalier RST

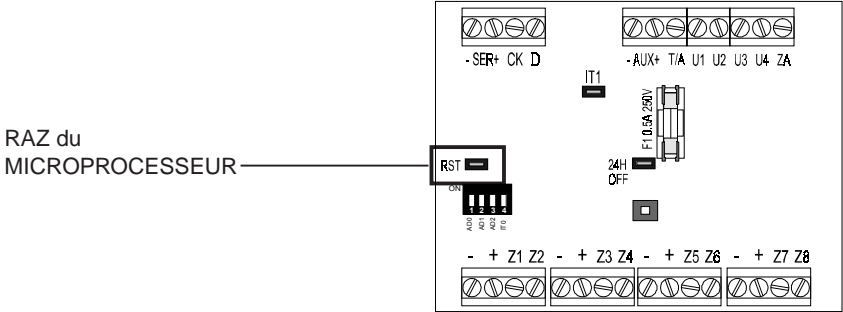

Modalité fermeture adresses

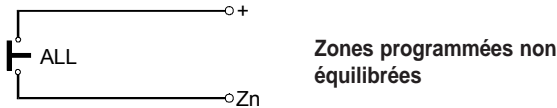
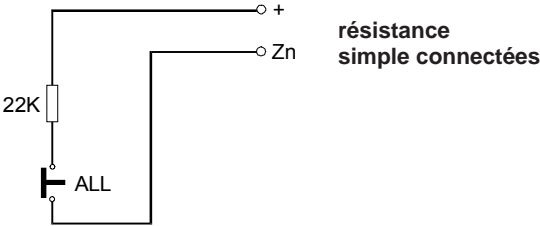

UTILISATION AVEC
MP110

EXTENSION ES100

Connexion et adressage
des modules BUS UR1Z

UTILISATION AVEC
MP105

UTILISATION AVEC
MP108

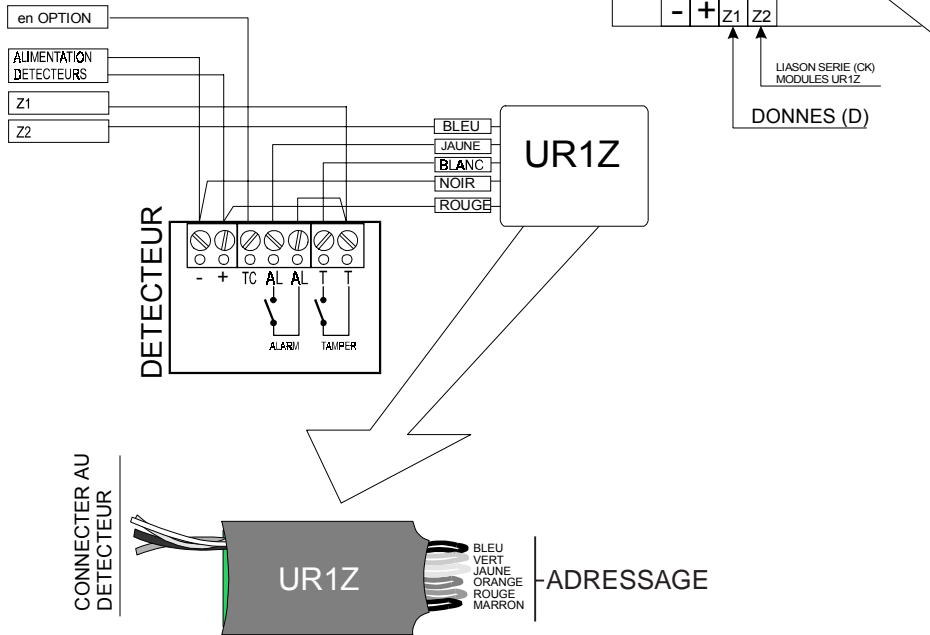

Pour adresser les détecteurs
(max 8 adress) il suffit de
couper les cavaliers de couleur
(voir la table à droite)



C = COUPE

IND.	BLE	VER	JAU	ORAN	ROU	MAR
1						C
2					C	
3					C	C
4				C		
5				C		C
6				C	C	
7				C	C	C
8			C			

USED WITH
MP110

Terminal Board Description

USED WITH
MP108

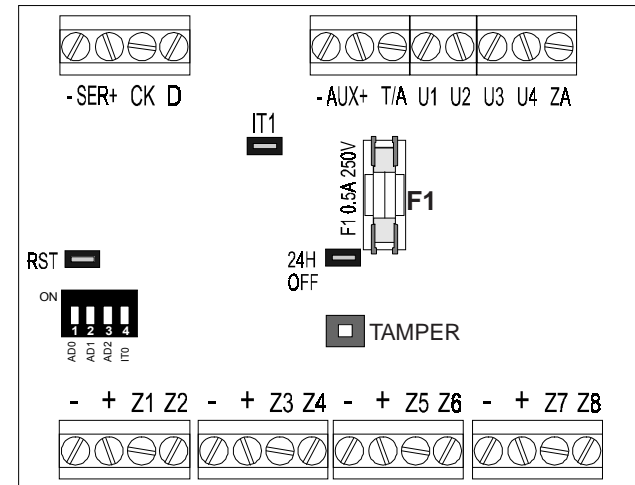

-SER Serial line power supply to devices
+SER Serial line power supply to devices
CK Serial connection(synchronism)
D Data

*to be connected to the keypad
and commutator serial line
inside the unit*

-AUX Negative auxiliary power supply input
+AUX Positive auxiliary power supply input

*use the positive and negative unit inputs
used to supply sensors*

T/A Tamper input(always balanced)
22 kohm balancing resistance

U1
U2
U3
U4 Electrical outputs(10/20mA)

*Freely programmable electrical outputs ;
(see unit manual)*

ZA Auxiliary zone (NC to negative)

See unit manual for programming

- Power supply negative
+ Power supply positive
Zn Zn Zone
Zn Zn Zone

Available for sensors